



BF1

GLASSLINED CYLINDERS

WITH REMOVABLE STAINLESS STEEL HEAT EXCHANGER (1.500 - 5.000 LITRES)



BF1 1500 - 2000 - 3000 - 5000

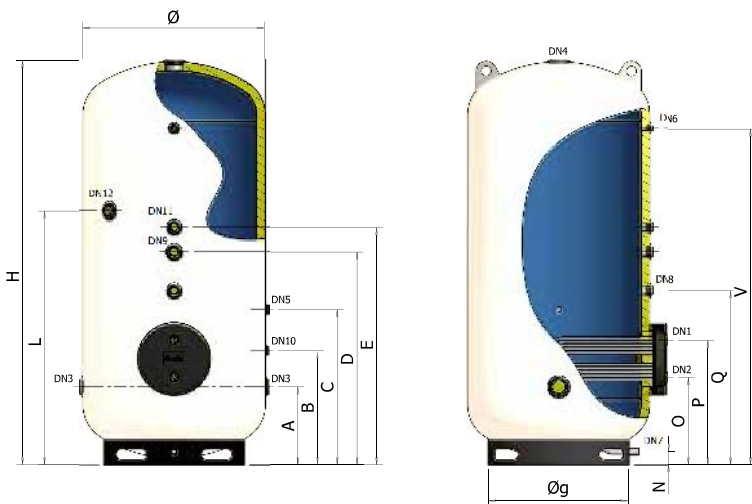

KEYWORD

DN1: Primary fluid inlet (heating side); **DN2:** Primary fluid outlet (heating side); **DN5:** Sanitary cold water inlet; **DN6:** Sanitary hot water outlet; **DN7:** Magnesium anode; **DN8:** Probes (Thermometer, Thermostat); **DN9:** Tank drain; **DN10:** Thermo-regulation; **DN11:** Recirculation.

- CYLINDER
- FOR SANITARY HOT WATER
- SUITABLE FOR SOLAR SYSTEMS
- INTERNAL, GLASSLINING ANTI-CORROSION TREATMENT
- POLYURETHANE INSULATION
- HEAT EXCHANGER IN STAINLESS STEEL AISI 304
- HANDLING BY FORKLIFT
- + 95°C WORKING TEMPERATURE
- +110°C HEAT EXCHANGER MAX TEMPERATURE
- P_{MAX}** 6 bar MAX WORKING PRESSURE
- P_{SECA}** 12 bar HEAT EXCHANGER MAX PRESSURE
- WARRANTY: 5 YEARS**

REFERENCE STANDARDS CYLINDER:

Directive PED 97/23/EC – ART. 3.3, without CE marking
Standard EN 12897:2006

INTERNAL GLASSLINING:

DIN 4753
The glasslining treatment makes the cylinder suitable to contain hot water for sanitary and hygienic use and resistant to corrosive phenomena.

INSULATION:

Expanded, flexible polyurethane with open cells.

HEAT EXCHANGER:

Removable U pipe stainless steel heat exchanger.

INSTALLATION:

- traditional boilers (wall-hung and/or floor-standing)
- condensing boilers
- solar thermal systems

MODEL	CODE	LOWER HEAT EXCHANGER					NOTES
		LITRES	m ²	LITRES	mm	mm	
BF-1 / 1500	A340H67 VW050	1500	3,00	15	1100	2465	
BF-1 / 2000	A340H70 VW050	2000	4,00	18	1200	2445	
BF-1 / 3000	A340H74 VW050	3000	6,00	24	1350	2840	
BF-1 / 5000	A340H80 VW050	5000	10,00	39	1700	3045	

MODEL	ANODE ø x ø conn. x L	DN	DN	DN	DN	DN	DN	DN	DN	DN	DN	DN	DN
		1	2	3	4	5	6	7	8	9	10	11	12
BF-1 / 1500	32 x 1.1/4" x 670	1.1/2"	1.1/2"	2.1/2"	3"	1.1/4"	1/2"	1"	1.1/4"	1.1/2"	1.1/4"	1.1/4"	2"
BF-1 / 2000	32 x 1.1/4" x 670	1.1/2"	1.1/2"	2.1/2"	3"	1.1/4"	1/2"	1"	1.1/4"	1.1/2"	1.1/4"	1.1/4"	2"
BF-1 / 3000	32 x 1.1/4" x 700	1.1/2"	1.1/2"	3"	3"	1.1/2"	1/2"	1"	1.1/4"	1.1/2"	1.1/4"	1.1/4"	2"
BF-1 / 5000	40 x 1.1/2" x 640	1.1/2"	1.1/2"	3"	3"	1.1/2"	1/2"	1"	1.1/4"	1.1/2"	1.1/4"	1.1/4"	2"

MODEL	A	B	C	D	E	F	G	I	L	M	N	O	P	Q	R	S	T	U	V
	mm	mm	mm	mm	mm	mm	mm	mm	mm	mm	mm	mm	mm	mm	mm	mm	mm	mm	mm
BF-1 / 1500	475	695	945	1295	1445	-	-	-	1545	-	80	530	755	1060	-	-	-	-	2045
BF-1 / 2000	465	685	935	1285	1435	-	-	-	1535	-	80	520	745	1050	-	-	-	-	2035
BF-1 / 3000	530	730	980	1480	1630	-	-	-	1730	-	80	565	790	1095	-	-	-	-	2380
BF-1 / 5000	635	835	1085	1585	1735	-	-	-	1835	-	80	670	895	1200	-	-	-	-	2485



TECHNICAL CHARACTERISTICS

HEAT EXCHANGER	CODE	MAXIMUM WORKING PRESSURE / MAXIMUM WORKING TEMPERATURE		PRESSURE DROP OF HEAT EXCHANGERS
		HOT WATER 12 BAR / 110 °C	SATURATED STEAM 2 BAR / 134 °C	
3,0 m ²	2950300 V0010	•	•	200 mbar
4,0 m ²	2950400 V0010	•	•	220 mbar
6,0 m ²	2960600 V0010	•	•	350 mbar
10,0 m ²	2961000 V0010	•	•	400 mbar

N.B. If using the heat exchanger with temperatures over 100 °C, ask for steam seals

MODEL	INSULATION TYPE	INSULATION THICKNESS	INSULATION DENSITY	INITIAL THERMAL CONDUCTIVITY	(*) INSULATION THERMAL LOSS	EXTERNAL FINISH
BF-1 / 1500	Flexible expanded polyurethane with open cells	50 mm	15 kg/m ³	39,0 mW/m K	6,53 kWh / 24h	Skay white RAL 9001
BF-1 / 2000					7,15 kWh / 24h	
BF-1 / 3000					9,18 kWh / 24h	
BF-1 / 5000					12,27 kWh / 24h	

(*) Thermal loss calculated with an accumulation temperature equal to 60 °C and with an external temperature equal to 15 °C.

SAFETY DEVICES

The cylinders must be protected against the effects of over pressure by installing:

- A **SAFETY VALVE** calibrated to pressure below the max pressure of the cylinder
- A **SANITARY EXPANSION TANK** mod. ELBI **D – DV series**

MODEL	RECOMMENDED SANITARY EXPANSION TANK (mod. ELBI D-DV series)
BF-1 / 1500	DV – 150
BF-1 / 2000	DV – 150
BF-1 / 3000	DV – 300
BF-1 / 5000	n°2 pcs DV – 200

Sized using the following parameters: T. accumulation= 85 °C / T. inlet = 15 °C / Pre-charge pressure = 3 bar / Max pressure = 6 bar
The recommended capacity must be verified on the basis of the actual dimensions of the system implemented.

MODEL	MAGNESIUM ANODE SUPPLIED	CATHODIC PROTECTION APPLICABLE
BF-1 / 1500	1,1/4" x 670 / Cod.8560070	Cathodic protection for cylinders 1500/2000 l. Code 8560180
BF-1 / 2000	1,1/4" x 670 / Cod.8560070	
BF-1 / 3000	1,1/4" x 700 / Cod.8560080	Cathodic protection for cylinders 3000/5000 l. Code 8560185
BF-1 / 5000	1,1/2" x 640 / Cod.8560100	

ACCUMULATION AT 60 °C

HEAT EXCHANGER: T.inlet = 80°C; ΔT = 10°C.

STORAGE WATER HEATER: T.inlet =15°C; T. accumulation = 60°C

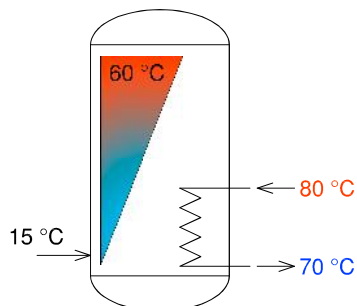

OPERATION WITH HOT WATER

MODEL	HEAT EXCHANGER [m ²]	THERMAL POWER [kW]	PUMP CAPACITY [l/hour]	HEATING TIME ⁽¹⁾ [min]	PRODUCTION DHW AT 60°C [l/hour]	QUANTITY DHW AT 45°C IN FIRST 10 min. ⁽²⁾ [l]
BF-1 / 1500	3,0	72,00	6400	70	1375	1243
BF-1 / 2000	4,0	98,00	8500	63	1828	1594
BF-1 / 3000	6,0	159,30	14100	58	3044	2524
BF-1 / 5000	10,0	250,70	22000	62	4790	4085

(1) Time required to bring the temperature of the cylinder from 15 °C to 60 °C.

(2) Quantity of DHW (Sanitary Hot Water) at 45°C available in the first 10 minutes with DHW accumulation at 60° C.

ACCUMULATION AT 45 °C

HEAT EXCHANGER: T.inlet = 80°C; ΔT = 10°C.

STORAGE WATER HEATER: T.inlet =15°C; T. accumulation = 45°C

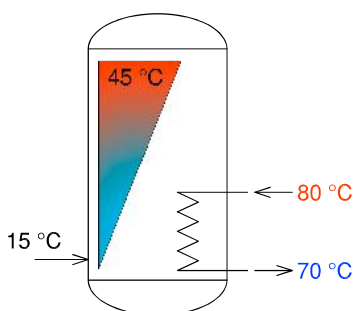

OPERATION WITH HOT WATER

MODEL	HEAT EXCHANGER [m ²]	THERMAL POWER [kW]	PUMP CAPACITY [l/hour]	HEATING TIME ⁽¹⁾ [min]	PRODUCTION DHW AT 45°C [l/hour]
BF-1 / 1500	3,0	92,00	8100	37	2635
BF-1 / 2000	4,0	131,60	11600	31	3770
BF-1 / 3000	6,0	223,60	19710	28	6410
BF-1 / 5000	10,0	339,00	29900	31	9720

1) Time required to bring the temperature of the cylinder from 15 °C to 45 °C.

ACCUMULATION AT 60 °C

HEAT EXCHANGER: T.inlet = 120°C (1 bar)

STORAGE WATER HEATER: T.inlet =15°C; T. accumulation = 60°C

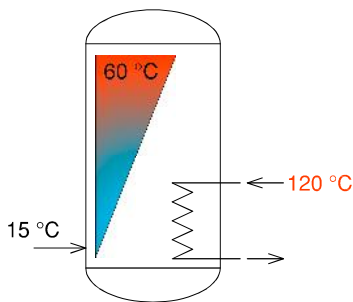

OPERATION WITH STEAM

MODEL	HEAT EXCHANGER [m ²]	THERMAL POWER [kW]	PUMP CAPACITY [l/hour]	HEATING TIME ⁽¹⁾ [min]	PRODUCTION DHW AT 60°C [l/hour]	QUANTITY DHW AT 45°C IN FIRST 10 min.
BF-1 / 1500	3,0	236,00	400	21	4600	2070
BF-1 / 2000	4,0	287,00	486	22	5575	2470
BF-1 / 3000	6,0	440,30	754	21	8400	3820
BF-1 / 5000	10,0	675,70	1143	23	12890	6020

(1) Time required to bring the temperature of the cylinder from 15 °C to 60 °C.

(2) Quantity of DHW (Sanitary Hot Water) at 45°C available in the first 10 minutes with DHW accumulation at 60° C.

ACCUMULATION AT 45 °C

HEAT EXCHANGER: T.inlet = 120°C (1 Bar)

STORAGE WATER HEATER: T.inlet =15°C; T. accumulation = 45°C

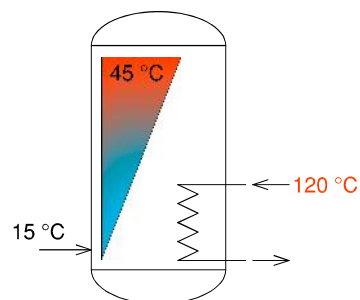

OPERATION WITH STEAM

MODEL	HEAT EXCHANGER [m ²]	THERMAL POWER [kW]	PUMP CAPACITY [l/hour]	HEATING TIME ⁽¹⁾ [min]	PRODUCTION DHW AT 60°C [l/hour]
BF-1 / 1500	3,0	265,60	450	13	7615
BF-1 / 2000	4,0	315,70	534	14	9048
BF-1 / 3000	6,0	495,00	839	13	14185
BF-1 / 5000	10,0	745,00	1263	14	21350

(1) Time required to bring the temperature of the cylinder from 15 °C to 45 °C.

ACCUMULATION AT 60 °C

HEAT EXCHANGER: T_{inlet} = 134°C (2 bar)

STORAGE WATER HEATER: T_{inlet} = 15°C; T_{accumulation} = 60°C

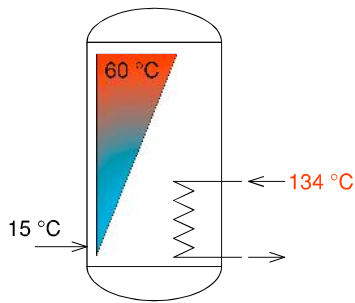

OPERATION WITH STEAM

MODEL	HEAT EXCHANGER [m ²]	THERMAL POWER [kW]	PUMP CAPACITY [l/hour]	HEATING TIME ⁽¹⁾ [min]	PRODUCTION DHW AT 60°C [l/hour]	Quantity DHW AT 45°C in first 10 min ⁽²⁾ [l]
BF-1 / 1500	3,0	278,00	479	19	5310	5310
BF-1 / 2000	4,0	338,00	583	18	6458	6458
BF-1 / 3000	6,0	525,00	905	18	10030	10030
BF-1 / 5000	10,0	790,00	1362	20	15095	15095

(1) Time required to bring the temperature of the cylinder from 15 °C to 60 °C.

(2) Quantity of DHW (Sanitary Hot Water) at 45°C available in the first 10 minutes with DHW accumulation at 60° C.

ACCUMULATION AT 45 °C

HEAT EXCHANGER: T_{inlet} = 134°C (2 bar)

STORAGE WATER HEATER: T_{inlet} = 15°C; T_{accumulation} = 45°C

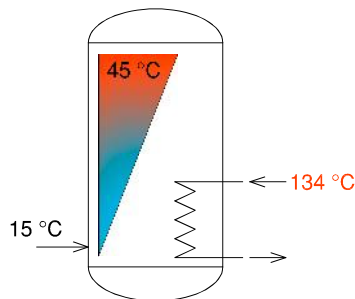

OPERATION WITH STEAM

MODEL	HEAT EXCHANGER [m ²]	THERMAL POWER [kW]	PUMP CAPACITY [l/hour]	HEATING TIME ⁽¹⁾ [min]	PRODUCTION DHW AT 45°C [l/hour]
BF-1 / 1500	3,0	306,30	528	11	8780
BF-1 / 2000	4,0	369,20	636	11	10580
BF-1 / 3000	6,0	645,00	1112	10	18485
BF-1 / 5000	10,0	820,00	1415	13	23500

(1) Time required to bring the temperature of the cylinder from 15 °C to 45 °C.

TABLE OF HEATING ELEMENT APPLICABILITY TO CYLINDERS

Heating element model*					Water heating time from 15° C to 60 °C (expressed in minutes) <i>The heating times outlined are approximate</i>			
CODE	Power (kW)	Voltage (Volt)	Connection	Length (mm)	BF-1 1500	BF-1 2000	BF-1 3000	BF-1 5000
8601000	1	220 V / MF	G 1,1/4"	295	4720 min.	6300 min.	9420 min.	15750 min.
8601650	1.65	220 V / MF	G 1,1/4"	450	2870 min.	3820 min.	5740 min.	9550 min.
8602000	2	220 V / MF	G 1,1/4"	515	2370 min.	3150 min.	4740 min.	7875 min.
8602600	2.6	220 V / MF	G 1,1/4"	675	1830 min.	2450 min.	3660 min.	6125 min.
8602601	2.6	220 V / MF	G 1,1/4"	360	1830 min.	2450 min.	3660 min.	6125 min.
8603300	3.3	220 V / MF	G 1,1/4"	825	1450 min.	1940 min.	2900 min.	4850 min.
8603301	3.3	220 V / MF	G 1,1/4"	435	1450 min.	1940 min.	2900 min.	4850 min.
8604001	4	220 V / MF	G 1,1/4"	510	1200 min.	1600 min.	2400 min.	4000 min.
8705000	5	380 V / TF	G 1,1/2"	445	950 min.	1300 min.	1900 min.	3250 min.
8706000	6	380 V / TF	G 1,1/2"	510	800 min.	1060 min.	1600 min.	2650 min.
8708000	8	380 V / TF	G 1,1/2"	670	610 min.	800 min.	1220 min.	2000 min.
8710000	10	380 V / TF	G 1,1/2"	820	490 min.	640 min.	980 min.	1600 min.
8712000	12	380 V / TF	G 1,1/2"	970	410 min.	540 min.	820 min.	1350 min.

n.a. =Heating element not applicable

SEE TABLE OF SYMBOLS
IN THE SHUTTER OF THE
COVER

